



Porte Ipad sur pied

Le porte Ipad sur pied est compatible avec l'Ipad 2 et 3. Il peut être mis en format portrait ou paysage et peut se fixer au sol pour plus de sécurité.



Caractéristiques et avantages :

- Format portrait ou paysage.
- Disponible en noir, blanc et argenté.
- Compatible avec les Ipad 2 et 3.
- Structure en acier.
- Vis et clés Allen incluses.

Caractéristiques de la structure

Dimensions de la structure assemblée:

Portrait : 1060mm (h) x 360mm (l)

Paysage : 1045mm (h) x 360mm (l)

Poids: 5,82 kg environ

Autres informations

Inclus dans le kit :

- Notice de montage
- Pied
- Tube en acier
- Porte Ipad
- Clé allen
- Vis









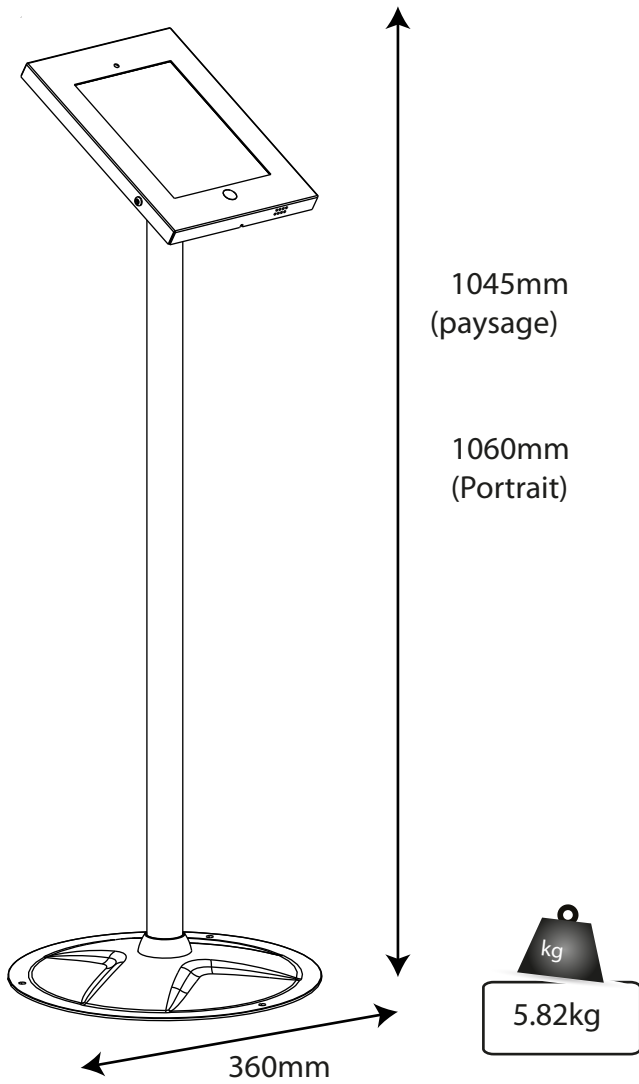



Ipad non fournis

Les dimensions sont approximatives

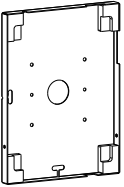
V1 - septembre 2013

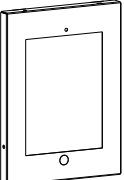
Notice de montage



| ÉLÉMENT | DESCRIPTION | QUANTITÉ | ÉLÉMENT | DESCRIPTION | QUANTITÉ |
|---------|---|----------|---------|---|----------|
| A | Tube | 1 | G |  M5x8 | 4 |
| B |  Support plastique | 1 | H |  M5x20 | 3 |
| C |  Rondelle métallique | 1 | I |  $\Phi 13.5 \times \Phi 5.5 \times 3.2$ | 2 |
| D |  Base du pied | 1 | J |  Clés Allen | 1 |
| E |  Porte Ipad arrière | 1 | K |  ST6.3x55 | 3 |
| F |  Porte Ipad avant | 1 | L |  ancrage pour béton | 3 |
| | | | M |  bouton tournant | 1 |
| | | | N |  D5 rondelles | 2 |

Notice de montage

